

# Installation Instructions

## AF20-10

Required Crew: 2 Required  
Concrete: 6-8, 80 lb. bags

### Required Tools:

- Wheelbarrow
- Step Ladder (6' or taller)
- Shovel
- Tape Measure
- Digging Bar or Pick
- Level
- Allen Wrench (Provided)
- Open end or Box Wrenches: 9/16", 3/4"
- Hammer or Mallet
- Ratchet Handle & Sockets: 9/16", 3/4"
- Marker Pen
- Drill: Cordless or electric, or impact driver

**Component Playgrounds is concerned about the safety of your vision. It is important that you choose to protect your vision by wearing proper safety glasses during each and every phase of this construction process.**

**PLEASE READ AND UNDERSTAND ALL INSTRUCTIONS BEFORE BEGINNING**

The AF20-10 can be installed as a one day project. The normal time required to install the AF20-10 is about 2-4 hours for a two man crew. This time requirement will vary dependent upon the composition of the soil and the speed of the installers. Mix and pour the concrete as the last step.

**\*Before digging, please obey local laws by notifying your local underground utilities marking organization\***



# Installation Instructions Model AF20-10

Ground Space: 13' x 12'

Residential Minimum Play Space 17' x 24'

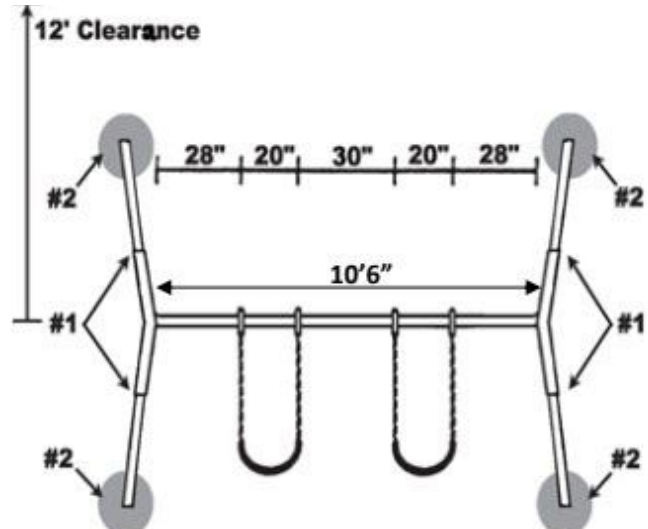

Holes 18" wide 12" deep  
(approx. 1.5-2 80 lb. bags  
concrete mix per hole)

A-Frame  
Legs

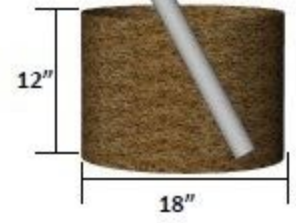

Hole Sizes for Cementing in the Set



# Top Rail Assembly



**Step 1:** Slide the ends of the 10' Top Rail as far as it will go into the Sleeves of the Triple Ends.

**Step 2:** Insert and tighten (4) 3/8" x 3/8" set screws into each of the Triple End Sleeves using Allen Wrench provided.

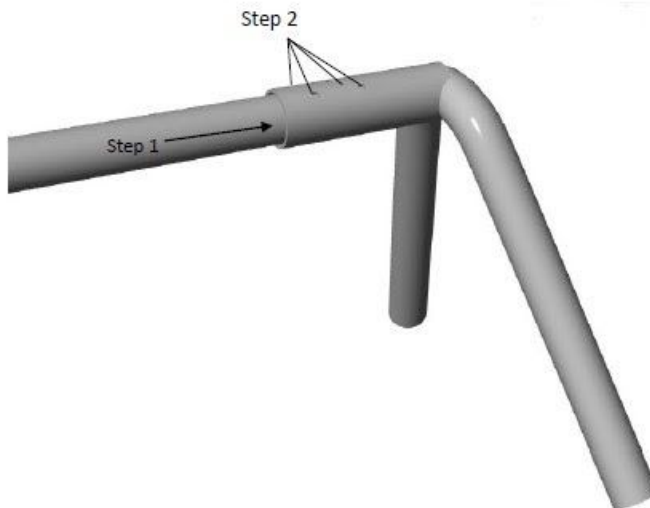

# Component Playgrounds

## BRASS BUSHING SWING HANGER

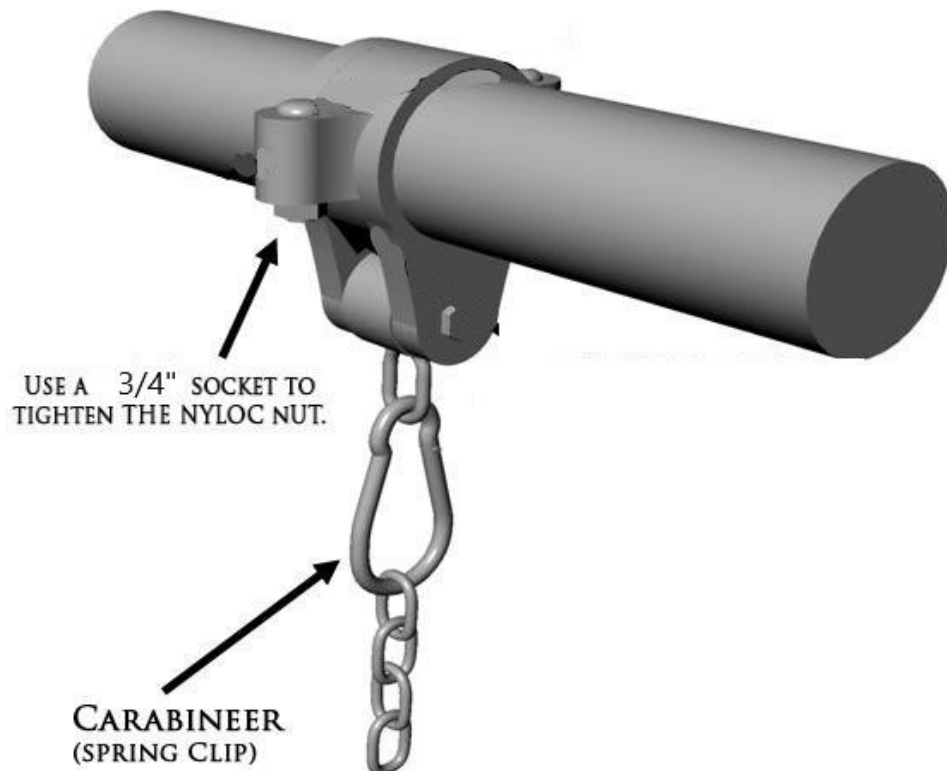

**1. Loosen and remove the two nyloc jam nuts. 2. Reassemble on to swing top rail. Tighten securely so that the hanger is firmly attached in place and cannot slide or swivel along top rail. 3. Attach carabineer with chain through the ring.**

**Note: We recommend you check the pendulum in the swing hangers at least every 6 months for normal wear.**

# ASSEMBLY

1. Slide the drilled end of the legs into the triple end. Find A-Frame Bolt Pack.
2. Align the holes in the legs with the holes in the triple end and join together using a  $3/8"$  x  $2\ 3/4"$  hex bolts and  $3/8"$  nyloc nuts. Tighten.
3. Insert and tighten set screws into triple end with allen wrench provided.

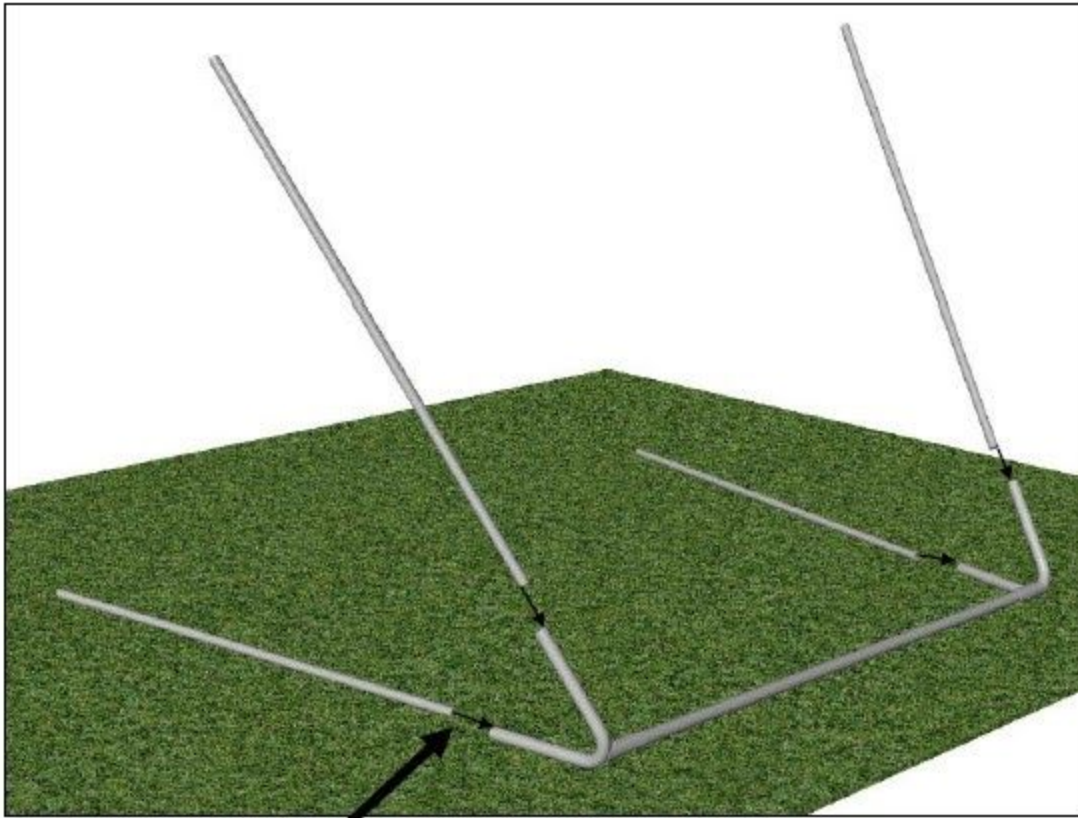

Make sure to install bottom legs first

$3/8"$  X  $2\ 3/4"$  Hex Bolt with  $3/8"$  Nyloc Nut

$3/8"$  X  $3/8"$  Set Screw

Slide in leg, bolt in place and secure with set screw

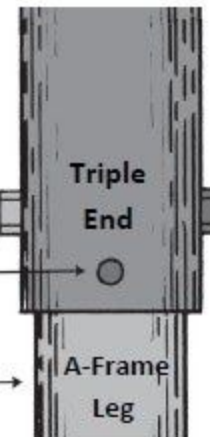

Next have two adults stand on opposite ends and stand structure up into the place you want it to be installed.

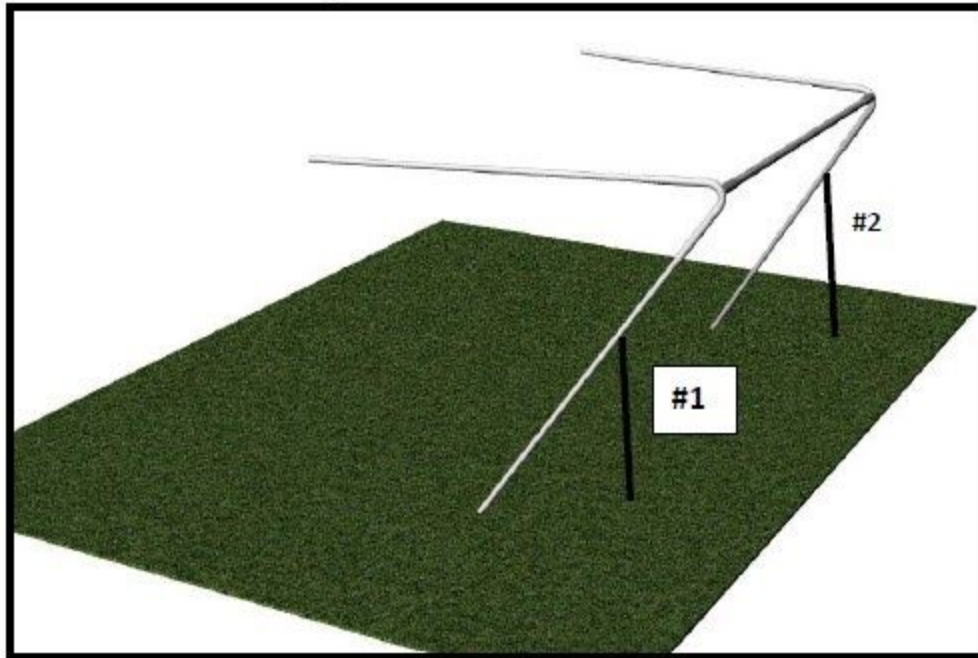

Mark holes around a-frame leg, move set to the side of markings and dig holes.  
**Notice! Most of the "A" frame leg hole needs to be dug towards the inside of the "A" frame leg.**

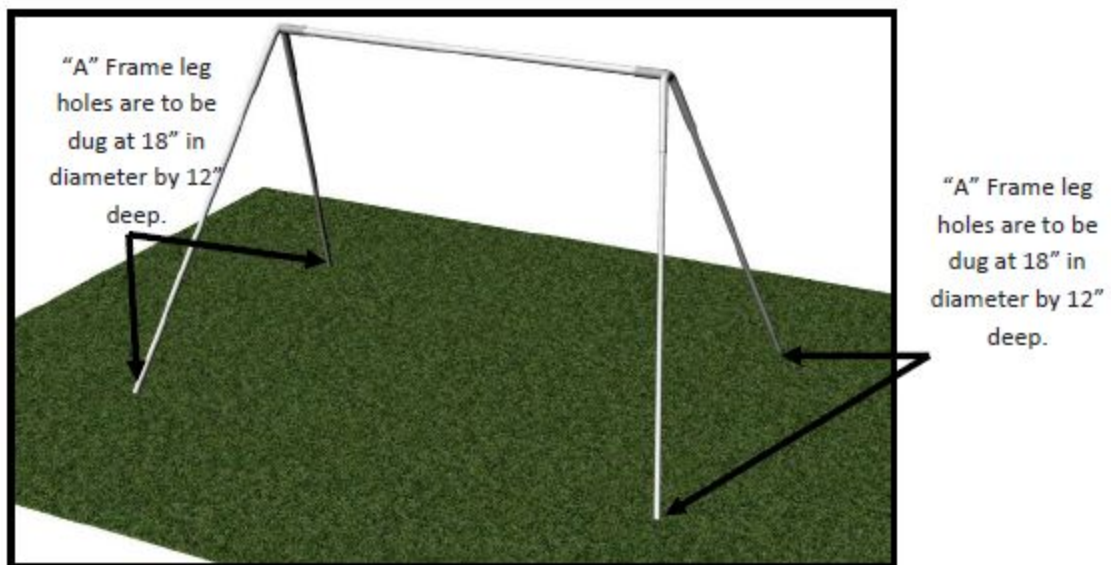

Place the set into the holes. Align the legs.

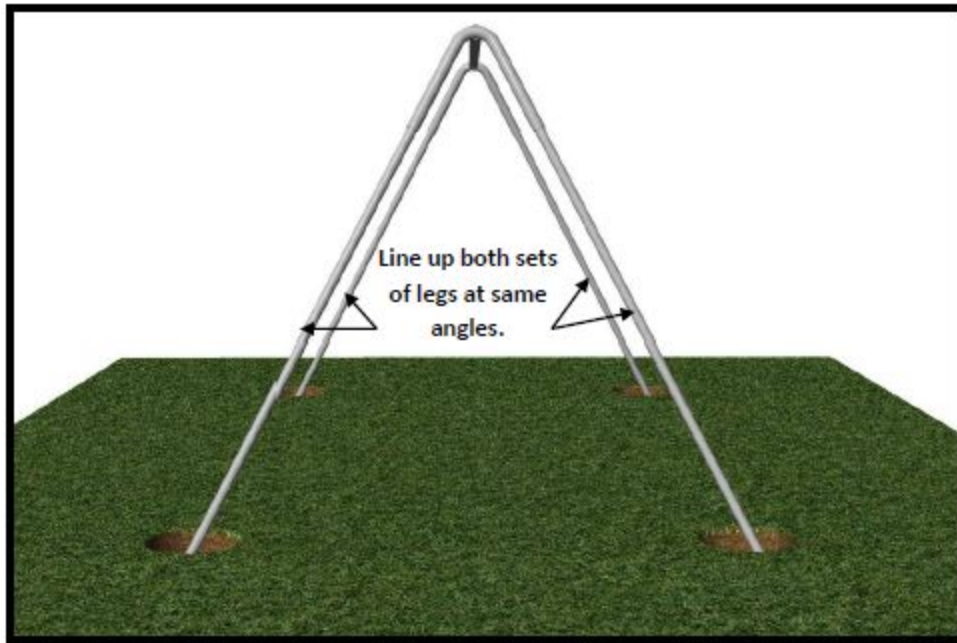

Place a level on the top rail and make the necessary adjustments to get set level.

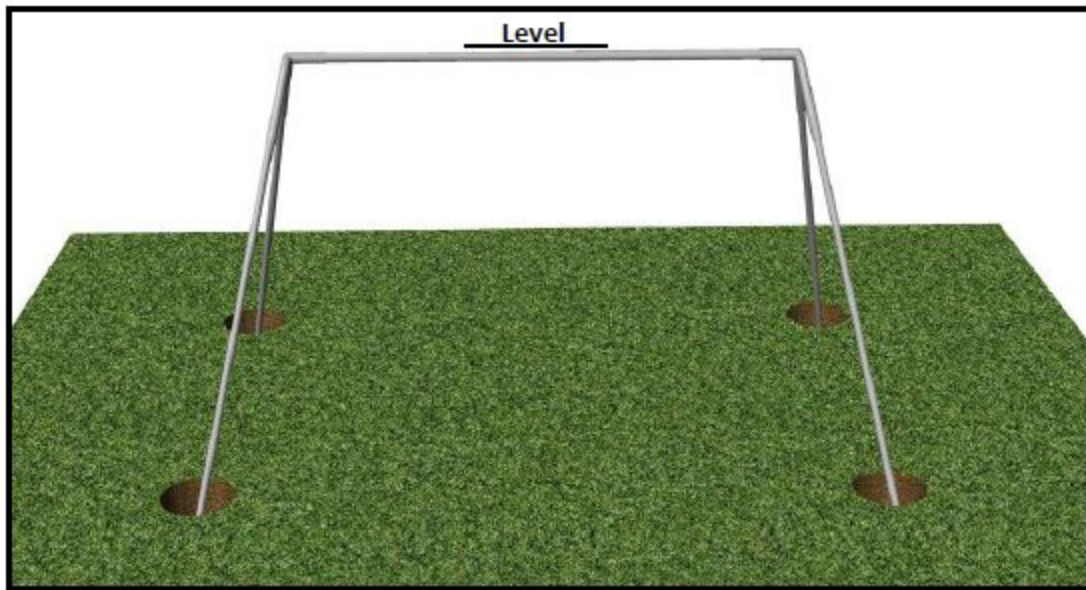

When you are satisfied that the structure is level, mix and pour the concrete according to the package directions. You will use approximately one and a half to two 80 lb. bags in each leg hole.

Concrete will cure faster in warm conditions and slower in cold conditions. The package directions on the concrete you buy will indicate approximate curing times. If you are in doubt, it is better to wait longer allowing the concrete more time to cure. We recommend 3-5 days before use.

The amount of concrete to be used in each hole may vary. For example: If you are installing your play structure into a grassy area, you may want to leave the concrete about three to four inches below the top of the hole. This will allow you to replace the sod and have enough soil depth for the grass to continue growing. As a result of this, you will use a lesser amount of concrete than someone who chooses to fill the concrete to the top of the hole. The concrete should only be filled to the top of the hole if you are planning to install 6 – 12 inches of soft fall ground cover. The concrete footings should never be exposed as this presents a potential risk of injury to those who use this play equipment.

**Double Check and Secure:** Before using your swing set, double check and secure any loose set screws or nuts and bolts and enjoy your Component Playground. **Allow all of the concrete to cure completely before using your playground. (3-5 days).**

After concrete has cured, assemble and attach swing chains and seats.



# Read Before Use

Congratulations! You have just purchased one of the finest pieces of playground equipment available. Your family will enjoy many hours of fun with this fine equipment. Playground equipment can be most enjoyable, but there are some dangers if not used properly. You should be aware of the following:

Equipment should be installed in a level area, free from obstructions, with enough space to allow for adequate clearance in all directions when equipment is in maximum use.

Keep objects away from equipment that could interfere with persons using it or that could be hazardous.

Misuse or abuse of this playground equipment is dangerous and can cause serious injury.

This equipment should be inspected before each use and any worn, defective or missing parts should be replaced.

Children should play on equipment only with adult supervision and should be duly warned of the potential hazards in this type of equipment when used improperly. Children should be instructed as to proper caution to take in its use.

Equipment should NOT be used when it is wet or icy.

Equipment should only be used in a well-lit area.

Do NOT use equipment when tired, under stress or emotionally upset.

Do NOT overcrowd.

Do NOT use equipment when under the influence of alcohol or drugs.

Do NOT attempt somersaults or gymnastic stunts on or using this equipment.

Know your own limitations and exercise caution at all times.

Do not jump off of equipment when dismounting. It is a dangerous practice to jump on or off equipment.

Do not attempt to use equipment for something other than the use for which it was designed and intended, or in a manner other than that for which it was designed and intended.

**While every attempt is made by Component Playgrounds to ensure the highest degree of safety in all of our equipment, we cannot guarantee freedom from injury. The user assumes all risk of injury due to use. All merchandise is sold on this condition, which no representative of the company can waive or change.**



## Maintenance of your playground

We hope that you and your family will enjoy many hours of great family fun while using your Component Playgrounds Products. We appreciate your business. Our goal is to provide safe, durable and fun products using the best materials available. Your product should be mostly maintenance free. However, you should consider the following suggestions with regard to the up keep of your new swing set.

- 1. Chains and Connectors:** The chains are coated with the highest quality bright zinc coating and the highest quality polymer coatings available. However, over time the zinc coating may become discolored or eventually have surface rust appear. The polymer coating may also become discolored with time and may eventually crack. This depends mostly upon environmental conditions and normally will not affect the durability and safety of the product. However, these items should be inspected regularly for excessive wear and should be replaced as necessary.
- 2. Swing Hangers:** These items are coated with a high quality galvanizing. However, swing hangers may become discolored or may eventually rust. Should this happen, a touch up using a cold galvanizing compound followed by a coat of silver aluminum spray paint will make them look new again. These items can be purchased in aerosol cans ("spray paint") at most hardware stores and at Component Playgrounds. The brass bushings inside of the swing hanger are impregnated with lubricant and will not generally require any further lubrication. However, these should be periodically inspected for wear and replaced as necessary. Note: Twisting the chains while swinging will put extra wear on the swing hanger parts. If your children enjoy this practice, please inspect the swing hangers more frequently.
- 3. Tire Swing Knuckles (for sets with a tire swing):** The tire swing knuckle arrives at Component Playgrounds pre-lubricated from the manufacturer. However, it is good practice to inspect the knuckle and be sure that there is adequate lubrication before it is used for the first time. After that, the tire knuckles should be lubricated at least twice annually to prevent excessive wear and the eventual failure of the tire swing knuckle.
- 4. Welds:** The heat from the welding process will damage the galvanizing that is on the pipe when it arrives to us from the manufacturer. This damage to the galvanizing is

restricted to the actual weld. When your equipment is built, Component Playgrounds will repair this damage using a cold galvanizing compound spray along with a top coat of silver aluminum. This is a time tested and durable process. However, when you are inspecting your playground equipment, if you notice that some surface rust has appeared on the welds, simply apply a fresh coat of the cold galvanizing compound and the silver aluminum top coat to keep your structure looking new. (These spray products can be purchased in aerosol cans (“spray paint”) at most hardware stores and at Component Playgrounds.)

5. **Plastic Lumber Platforms:** If you have purchased a structure which includes a platform, the plastic lumber does not need to be finished or stained. It is 100% maintenance free. However, you may need to occasionally hose it down to remove dirt and other debris that may collect after many hours of use by happy children.
6. **Vinyl Canopies:** If you have purchased a structure which includes a vinyl canopy, this product should be inspected occasionally for wear and will need to be replaced as necessary. Depending upon your environmental conditions, the normal life expectancy of the vinyl canopy is 3 – 5 years.
7. **Swing Seats:** These should be inspected at least twice annually and should be replaced as necessary.
8. **Slides:** Slides should never be lifted at the bottom. Lifting the slide at the bottom will almost always cause the slide to crack at the top where it has been attached to the platform or bracket. Cracks and wear such as is caused by this practice are easily identifiable and will not be covered under the product warranty.  
  
Slides should be inspected at least annually to ensure that the sliding surface is in good condition. Also inspect the side rails to be sure that the plastic has not been cut or gouged in any manner which would present the risk of injury while sliding.
9. **Fasteners:** All fasteners should be periodically inspected to make certain that they are tight and secure. Re-secure as necessary.

**\*For Safety please inspect all moving parts on a regular basis. (At Least Yearly)  
Especially paying attention to wear within the swing hanger.**



### **To Help Prevent Injuries from Falls & Other Hazards**

1. Never attach, or allow children to attach the following items to your swing set: Ropes, jump ropes, clotheslines, pet leashes or any similar type of item to your swing set. Any item such as these may present a strangulation hazard.
2. Periodically inspect all nuts, bolts, set screws, clevis, and carabineer or "S" hooks. Make certain that these are functionally safe and secure. If you have any doubt as to the safety and security of any connector or fastener, replace it.
  - 2a. You should periodically check the brass bushings in the swing hangers. Look for excessive wear in the bushing and replace as necessary.
  - 2b. If your playground has a tire swing: The tire swing knuckle should be lubricated twice annually to prevent wear.
3. Never allow children to wear bicycle helmets when using playground equipment.
4. Remove drawstrings from hoodie's and jackets. Remove attached mittens and gloves. These can become entangled with the equipment and present the risk of strangulation or other hazards.
5. Playground surfaces can become hot in the sun. Children should be required to wear shoes and socks when using this or any playground equipment.
6. Check for and remove sharp points or edges in the playground equipment.
7. Remove tripping hazards from the playground area. Items such as exposed concrete footings, tree stumps, rocks or any item that may be present in your space that a child could trip over while playing should be removed.
8. Regularly check the play equipment and the surfacing surrounding it to be certain that both are in good condition.
9. Parental Supervision is recommended. The best ingredient for a safe playground is good parental supervision while the kids are using the equipment.
10. Remember to play safely, take turns, share with each other and have fun!

## Residential Products Limited Lifetime Warranty

Component Playgrounds works to build heavy duty products that will stand up to the heavy use of active children. You can trust Component Playgrounds because of the way we design and build our products. We make products that are simple to own, and easy to maintain. This adds up to the best value on playground products that you can count on, and that kids will play on time after time.

Component Playgrounds warrants to the original purchaser/property owner that its' residential grade products are free from defects in materials and workmanship. This warranty is non-transferrable and will be honored only after proper registration.

This warranty is not extended to cosmetic items such as scratches, dents, fading, discoloring, paint wear, rust, weathering, or decorations. The warranty as stated is valid only if equipment is properly installed as detailed in the installation instructions provided and is used in a normal and expected manner. Excessive and or use above that which is normally expected may void the warranty. All parts are subject to normal wear for the purpose of which they were designed.

When attached to the structure, plastic slides should not be lifted up from the bottom for any reason. Cracks at the top of the slide that result from lifting the bottom of the slide will not be covered under the terms of this warranty.

This warranty is void should the equipment be subject to vandalism, misuse, neglect, abuse, improper installation, tampering, or accident. This equipment is not to be altered, or modified, by anyone other than Component Playgrounds or its authorized agent. This warranty does not cover damage resulting from flood, fire, catastrophe or other acts of nature.

To the extent permitted by law, Component Playgrounds shall not be liable for any direct, indirect, special, incidental, or consequential damages.

Should it be found that your product has parts that are defective within the warranty period, contact Component Playgrounds. *Unauthorized returns will be refused and returned to sender.* Defective part(s) must be photographed from a minimum of three different angles that clearly show the problem, and the installation of the defective part by itself and in relation to the rest of the structure. After speaking with a representative at Component Playgrounds: Return parts, freight prepaid, to the Component Playgrounds' plant with proof of purchase for repair or replacement. Component Playgrounds will evaluate the part(s) and the photographs and decide if the part(s) in question should be repaired or replaced. This warranty does not cover costs related to removal, transportation and/or labor.

This equipment is rated as commercial grade for residential use and is intended to be used in a private residential environment. This equipment may not meet all of the safety guidelines as described by the CPSC as it relates to public use/commercial playground equipment. For more information on public or commercial playgrounds, please visit [www.cpsc.gov](http://www.cpsc.gov).

Component Playgrounds sales representatives or its agents are not authorized to modify or substitute claims which are not part of this exclusive written warranty. This warranty is void if the product is in any way modified from its original state, or if it is used for purposes other than the purpose for which it was intended.

\*For children with special needs who may spend many hours of the day swinging, we recommend our heaviest swing set, the Arch Swing Model. This is the product for you!



# Warranty Registration Sheet

**Note: To ensure your warranty is activated, complete and return this form within 10 days of installation.**

Return this form via e-mail to:

[Sales@componentplaygrounds.com](mailto:Sales@componentplaygrounds.com)

Or via U.S. mail to:

Component Playgrounds  
1630 North Beck Street  
Salt Lake City, UT 84116

Today's Date:

\_\_\_\_\_

Sales Receipt/Invoice Number:

\_\_\_\_\_

Model(s):

\_\_\_\_\_

\_\_\_\_\_

\_\_\_\_\_

**\*For safety please inspect all moving parts on a regular basis (At least yearly). Especially paying attention to wear within the swing hanger.**

## Customer Information

Name:

Address:

City:

State:

Zip:

Phone:

Purchase Date:

Completion Date:

## Sales Representative/Dealer Information

(If different from manufacturer)

Organization:

City:

State:

Zip:

Sales Rep Name:

Phone:

## Installation Information

(If different from customer or sales representative)

Installed by:

Contact Person:

Address:

City:

State:

Zip:

Phone: